

This article was published in ASHRAE Journal, November 2010. Copyright 2010 American Society of Heating, Refrigerating and Air-Conditioning Engineers, Inc. Reprinted here by permission from ASHRAE at www.taylor-engineering.com. This article may not be copied nor distributed in either paper or digital form by other parties without ASHRAE's permission. For more information about ASHRAE, visit www.ashrae.org.

Economizer High Limit Controls and

Why Enthalpy Economizers Don't Work

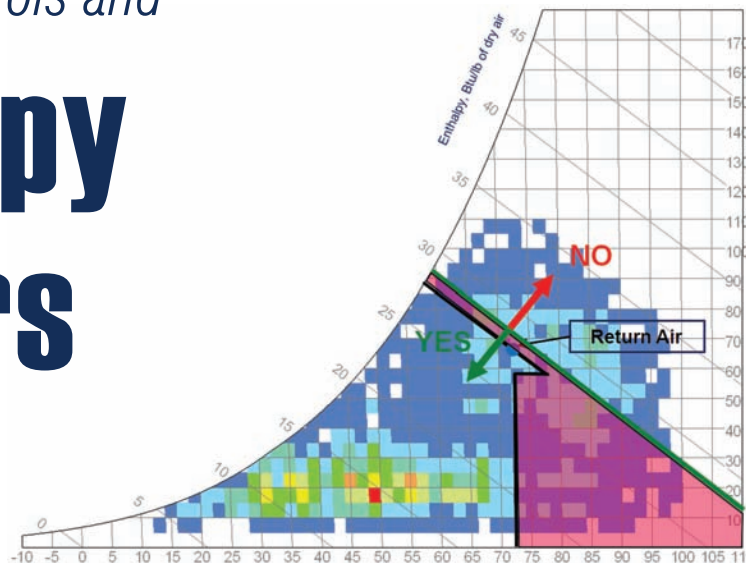

By **Steven T. Taylor, P.E.**, Fellow ASHRAE; and **C. Hwakong Cheng**, Member ASHRAE

Outdoor air economizers use controllable dampers to increase the amount of outside air drawn into the building when the outside air is cool or cold and the system requires cooling. They are required by energy standards such as Standard 90.1¹ in most commercial cooling applications. A typical design is shown in *Figure 1*. Supply air temperature is maintained at setpoint by first opening the economizer outdoor air damper and closing the return air damper, then opening the chilled water valve if additional cooling is required. A key element of the economizer control system is the high limit switch that determines whether outdoor air is, in fact, appropriate for cooling and enables or disables the economizer dampers accordingly. This high limit device, which has long been misunderstood, is the subject of this article.

The purpose of the high limit switch is to disable the economizer when its use would increase the energy used by the cooling coil, i.e., when cooling return air will use less mechanical cooling

energy than cooling outdoor air. Determining when the changeover condition occurs is complicated by the fact that cooling coils both cool and dehumidify supply air. *Figure 2* is a psychrometric

chart showing entering coil conditions that have a higher dew-point temperature than the desired supply air temperature so the air is dehumidified (wet coil). Coil cooling energy is proportional to the enthalpy difference across the coil from the entering condition to the supply air condition. The return air condition in this example is 76°F (24°C) dry-bulb temperature with a humidity ratio of 68 grains/lb_{da} (0.01 g_w/g_{da}) (1 grain = 7,000 lb_w). If the outdoor air were 78°F and 60 grains/lb_{da} (26°C and 0.09 g_w/g_{da}) (outdoor air condition #2, green dot, *Figure 2*), the enthalpy difference across the coil would be less than that required to cool return air to the supply air temperature despite the fact that the

About the Authors

Steven T. Taylor, P.E., is a principal and **C. Hwakong Cheng** is a designer at Taylor Engineering LLC, a consulting engineering firm in Alameda, Calif.

dry-bulb temperature is higher than the return air dry-bulb temperature. This is because the outdoor air results in a lower latent cooling load. Conversely, if the outdoor air were 74°F and 92 grains/lb_{da} (23°C and 0.13 g_w/g_{da}) (outdoor air condition #1, red dot, *Figure 2*), it would take more energy to cool than the return air despite having a lower dry-bulb temperature, due to the higher latent load component. So, with a wet coil (if the return air has a higher dew-point temperature than the supply air temperature setpoint, assuming near saturated conditions leaving the coil as is typical of a wet coil), the optimum economizer high limit logic is to cool the airstream that has the lower enthalpy.

The physics of a dry coil is quite different. In *Figure 3*, entering coil dew-point temperatures are below the supply air temperature dew point, so no dehumidification occurs. The energy use across the coil is still proportional to the enthalpy difference, but the leaving air is no longer near saturation; the humidity ratio is the same as the entering airstream. With a dry coil, cooling outdoor air from 81°F and 46 grains/lb_{da} (27°C and 0.07 g_w/g_{da}) takes more energy than cooling the return air, despite a lower enthalpy. Therefore, optimum dry coil logic is to cool the airstream that has the lowest dry-bulb temperature, regardless of humidity.

These two figures are combined in *Figure 4*. Interestingly, only seldom is this combined wet/dry (enthalpy/dry-bulb) logic recognized as being optimum.² For instance, ASHRAE's new green building Standard 189.1³ has requirements for enthalpy and dry-bulb high limit devices, but no requirement for combined enthalpy and dry-bulb high limit logic.

In these figures and in the discussion later, it is assumed that the economizer is fully "integrated," meaning the economizer and mechanical cooling can operate simultaneously. This is always true of chilled water systems and those direct expansion (DX) systems with modulating or several stages of capacity control, but it is generally not the case for small DX units with limited unloading capability. The optimum economizer control for non-integrated or partially integrated DX equipment will vary by application and, in humid climates, must consider the impact on space humidity that results from compressor cycling. The results and recommendations discussed below may not apply to these non-integrated economizers. For fully integrated economizers, the selection of high limit control will not cause any increase in humidity in humid weather. This can be seen in *Figure 2*; the supply air condition is the same regardless of entering air condition, and it is the supply air condition that determines the room humidity.

In these figures and in the discussion later, it is assumed that the economizer is fully "integrated," meaning the economizer and mechanical cooling can operate simultaneously. This is always true of chilled water systems and those direct expansion (DX) systems with modulating or several stages of capacity control, but it is generally not the case for small DX units with limited unloading capability. The optimum economizer control for non-integrated or partially integrated DX equipment will vary by application and, in humid climates, must consider the impact on space humidity that results from compressor cycling. The results and recommendations discussed below may not apply to these non-integrated economizers. For fully integrated economizers, the selection of high limit control will not cause any increase in humidity in humid weather. This can be seen in *Figure 2*; the supply air condition is the same regardless of entering air condition, and it is the supply air condition that determines the room humidity.

High Limit Control Strategies

The most common high limit controls are:

- Fixed dry-bulb temperature;
- Differential (or dual) dry-bulb temperature;
- Fixed enthalpy;

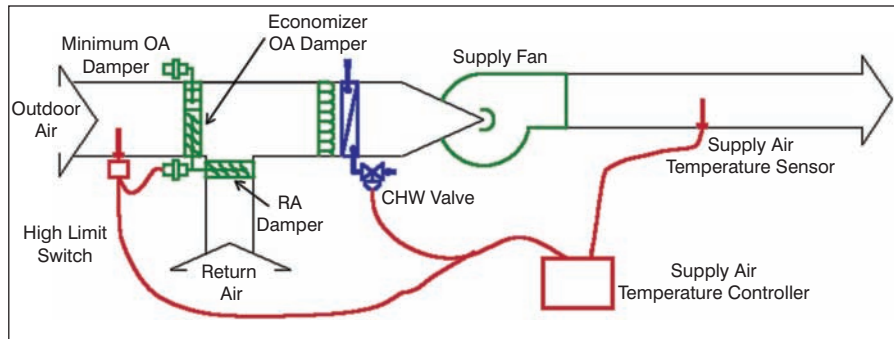

Figure 1: Outdoor air economizer controls.

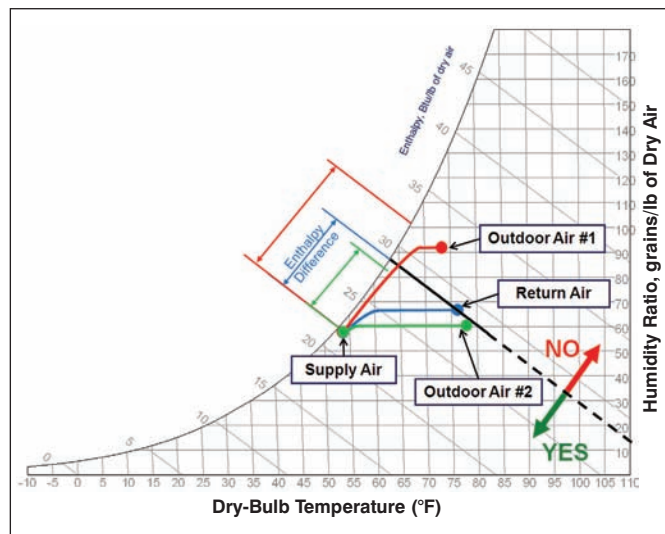

Figure 2: Optimum high limit logic: wet coil.

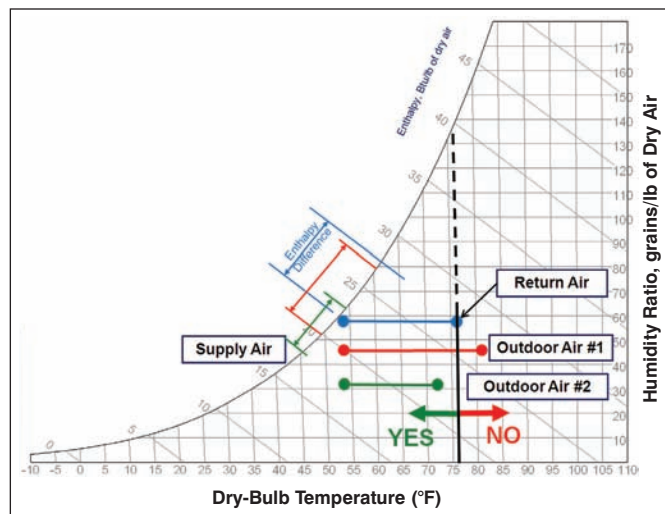

Figure 3: Optimum high limit logic: dry coil.

- Differential (or dual) enthalpy; and
- Combinations of the above.

Each of these controls has inherent errors—conditions where they make the wrong choice between the outdoor air and return airstreams—causing an increase in energy use

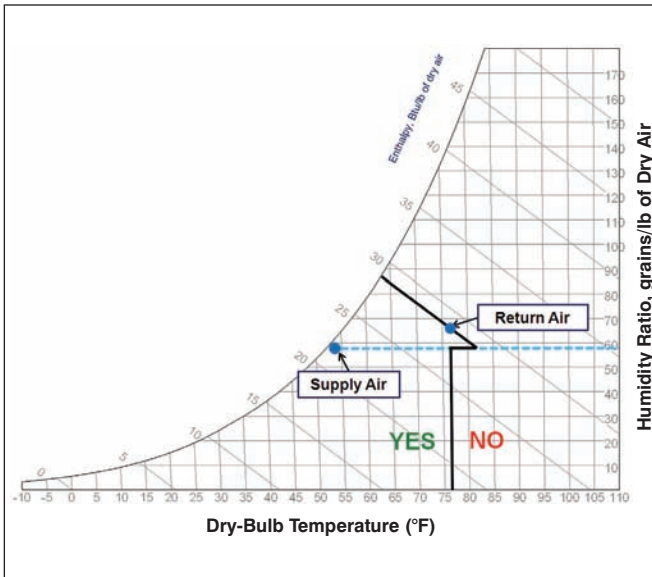

Figure 4: Optimum high limit logic: wet or dry coil.

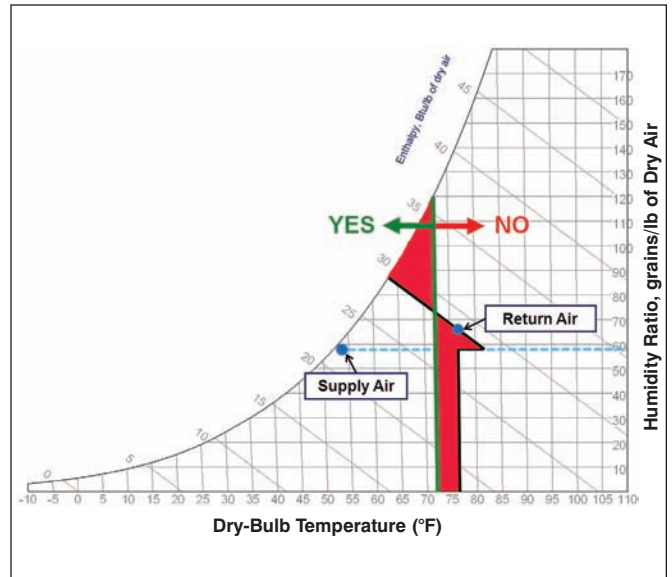

Figure 5: Fixed dry-bulb high limit error: setpoint 72°F.

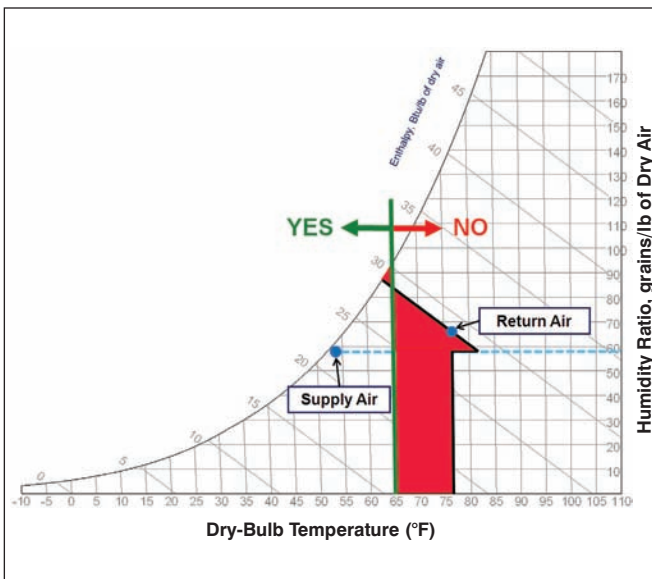

Figure 6: Fixed dry-bulb high limit error: setpoint 65°F.

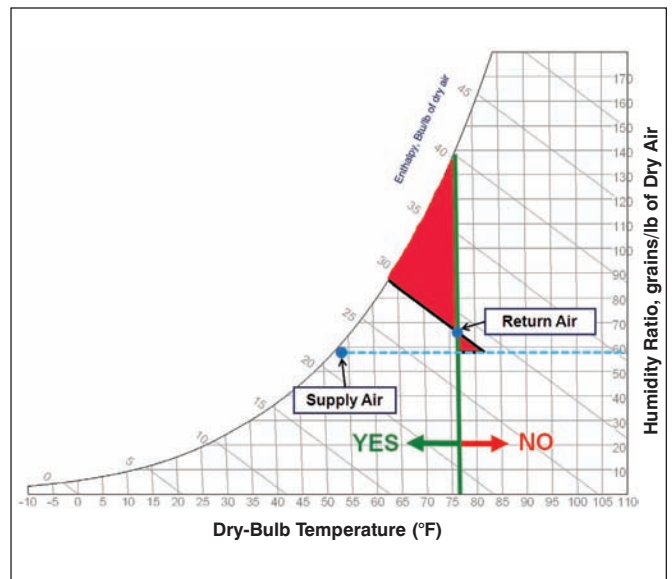

Figure 7: Differential dry-bulb high limit error.

compared to the ideal logic (Figure 4). These errors increase in practice due to sensor calibration error. These issues are discussed in more detail for each high limit control below.

Fixed Dry-Bulb Temperature

With a fixed dry-bulb high limit, outside air temperature is measured and compared to a fixed setpoint, enabling the economizer if the outdoor air temperature is below the setpoint. This was the first, and remains the simplest and least expensive high limit control, requiring only a single temperature sensor or thermostat mounted in the outdoor airstream.

Figure 5 is a psychrometric chart showing fixed dry-bulb control with setpoint equal to 72°F (22°C) superimposed over ideal control. The areas shaded in red represent outside air con-

ditions where the control strategy makes an error by incorrectly selecting the more energy intensive airstream. In this example, the return air is 76°F and 68 grains/lb_{da} (24°C and 0.01 g_w/g_{da}); this condition varies throughout the year. In the upper red triangle, the control incorrectly supplies humid outdoor air. In the lower red rectangle, the control incorrectly disables the economizer when outdoor air would have reduced coil load.

Figure 6 is the same chart with a setpoint of 65°F (18°C). This setpoint reduces the number of hours the control incorrectly supplies humid air (upper triangle), but it increases the number of hours when the economizer incorrectly is disabled in dry weather. In humid climates, those with many hours in the upper triangle and fewer hours in the lower rectangle, this lower setpoint will improve efficiency. This will be seen in the energy simulations discussed below.

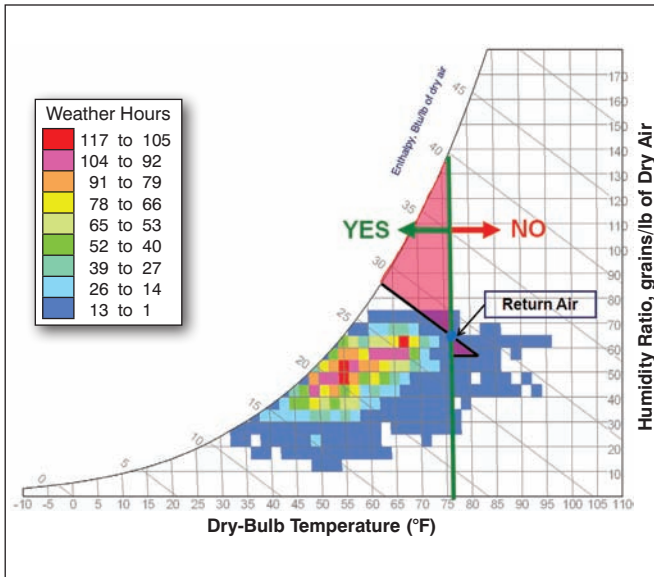

Figure 8: Differential dry-bulb high limit error: San Francisco.

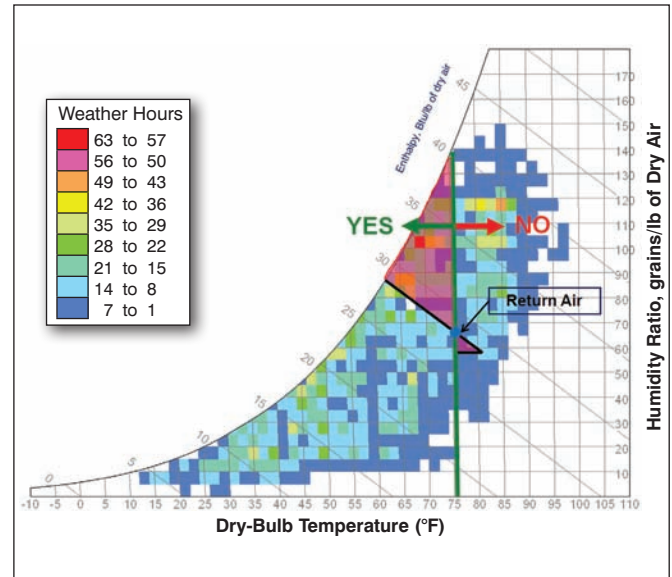

Figure 9: Differential dry-bulb high limit error: Atlanta.

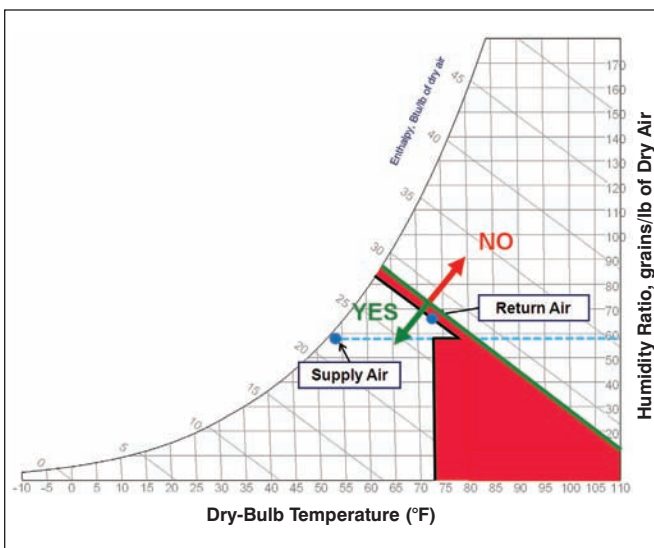

Figure 10: Fixed enthalpy high limit error: San Francisco.

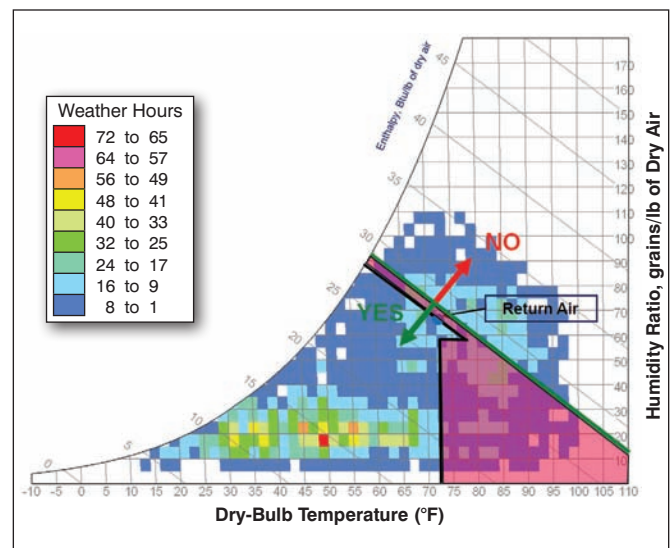

Figure 11: Fixed enthalpy high limit error: Albuquerque.

Differential Dry-Bulb Temperature

With a differential dry-bulb high limit, both outside air and return air temperatures are measured and the economizer is disabled when the outside air temperature exceeds the return air temperature. This control logic will always make the right choice (barring sensor error) between airstreams when the coil is dry (Figure 7, see Page 3), but also always makes an error when outdoor air is cool but humid (upper triangle). The impact of this error depends on the climate. It will have almost no effect in San Francisco (Figure 8) since there are very few hours with the outdoor air conditions in this error triangle. But the error will be significant in Atlanta (Figure 9) where there are many hours in this error triangle. In these figures, the annual number of hours between 6 a.m. and 6 p.m. at each psychrometric condition is indicated by a colored square indicating the frequency as indicated in the scale on the left.

Fixed Enthalpy

Fixed enthalpy high limit controls measure outside air enthalpy and compare it to a fixed setpoint, typically equal to the expected enthalpy of the return air (e.g., 28 Btu/lb_{da} [65 kJ/kg]), disabling the economizer if the outdoor air enthalpy is above the setpoint. Typically, for digital control systems, enthalpy is calculated from a temperature sensor and a relative humidity sensor. Enthalpy can also be measured with a dedicated enthalpy sensor, but this is actually the same two sensors built into a single housing with the enthalpy output signal calculated electronically from temperature and humidity. Since knowing temperature and humidity separately is usually desirable, most digital control systems use separate sensors.

Fixed enthalpy logic has two errors: 1) a small error caused when the setpoint is above or below the actual return air condition (the red rectangle parallel to the enthalpy lines, and 2) a

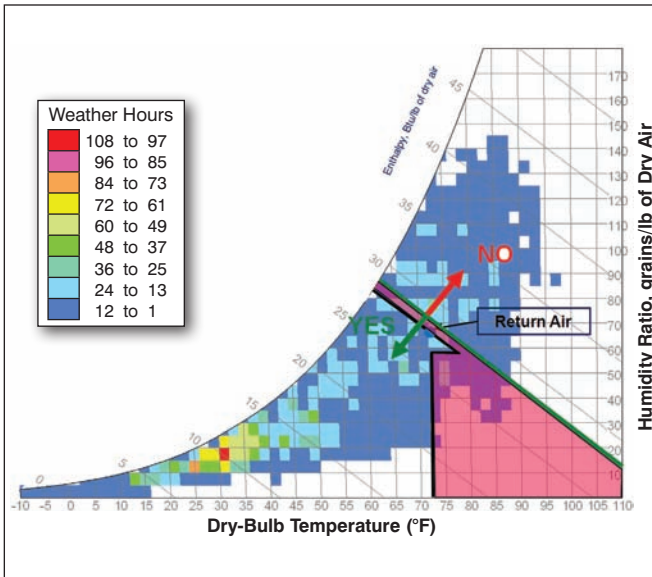

Figure 12: Fixed enthalpy high limit error: Chicago.

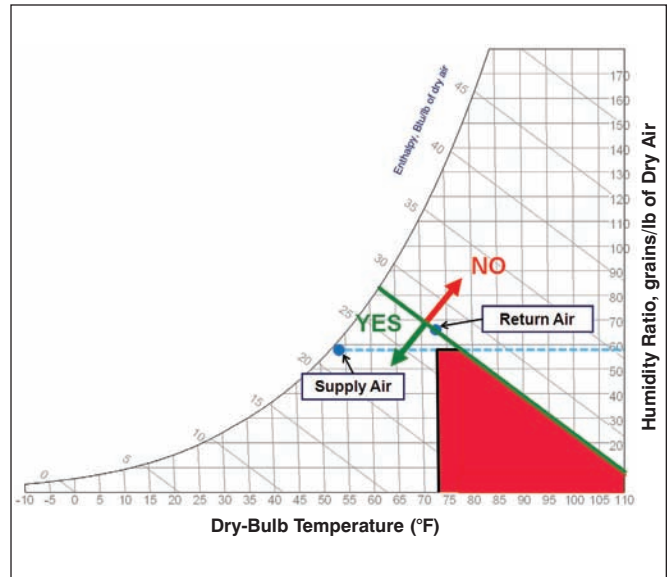

Figure 13: Differential enthalpy high limit error.

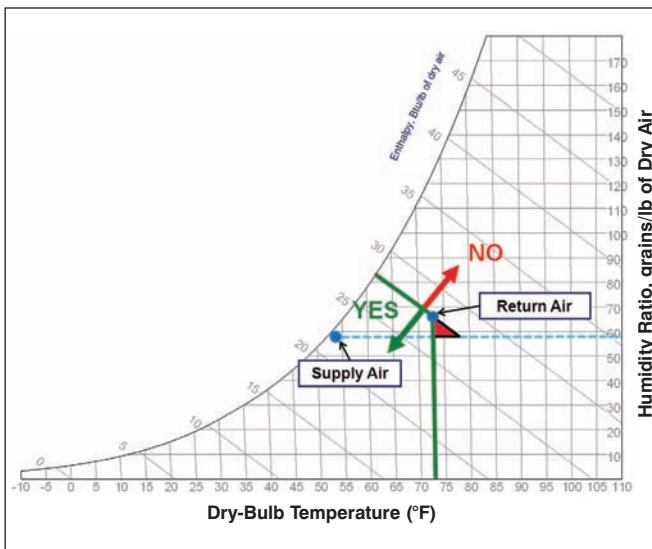

Figure 14: Error for a combination high limit of differential dry bulb and differential enthalpy.

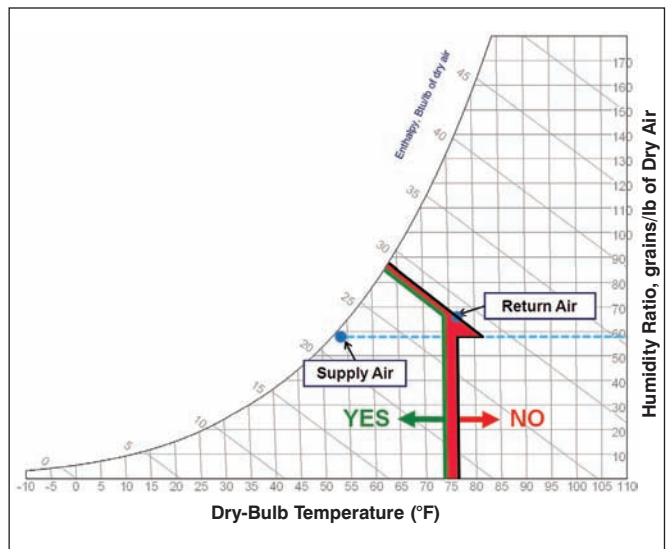

Figure 15: Error for a combination high limit of fixed dry bulb and fixed enthalpy.

large error when the coil is dry (lower red trapezoid). The former error seldom has a significant impact on energy performance, although return air conditions will vary year-round. This is because the setpoint only has to be near the actual return air enthalpy when the economizer needs to be turned off, i.e., when outdoor air conditions are hot or humid, and the return air enthalpy tends to be consistently around 28 Btu/lb_{da} (65 kJ/kg) under those conditions. The impact of the dry-coil error varies with climate. If the weather is dry, as in Albuquerque (Figure 11, see Page 4), the energy impact can be significant. If the weather is more humid, as in Chicago (Figure 12), the impact is very small.

Differential Enthalpy

Differential enthalpy high limit controls measure the enthalpy of both the outside air and return airstreams and disable

the economizer when the outside air enthalpy exceeds that of the return air. Because this control requires four sensors (temperature and relative humidity of outdoor air plus temperature and relative humidity of the return air), it is the most expensive and most prone to sensor error. Contrary to common knowledge (and to green building standards such as Standard 189.1), differential enthalpy is not the most efficient high limit logic, even theoretically, as can be seen by Figure 13. The control logic will be in error when the coil is dry and outdoor air is warm and dry.

Combination High Limits

From Figure 4, it is clear that combinations of the dry bulb and enthalpy high limit controls can be the most efficient. Figure 14 shows that combination differential dry bulb and

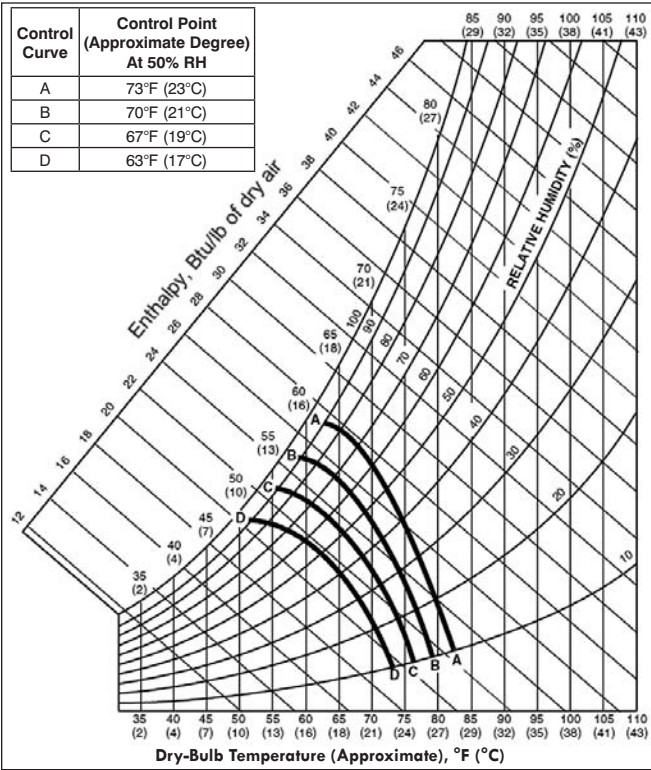

Figure 16: Electronic enthalpy controller.¹⁰

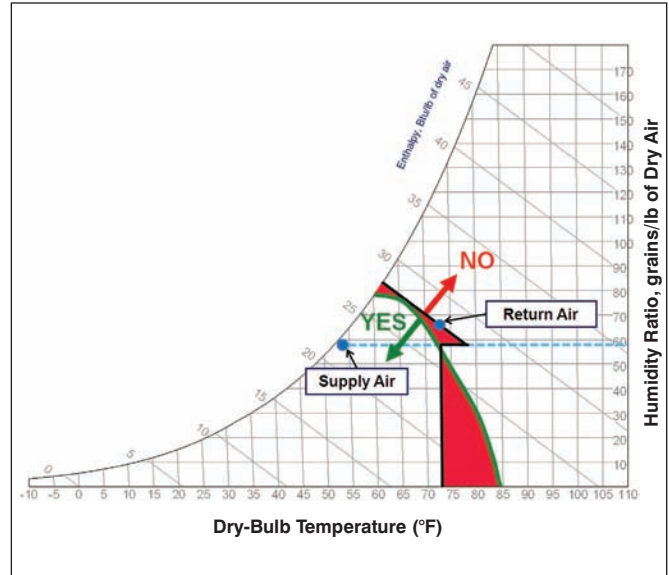

Figure 17: Electronic enthalpy controller error: "A" setting.

differential enthalpy high limit will have almost no theoretical error. A combination fixed dry bulb and fixed enthalpy high limit will be almost as effective (Figure 15, see Page 5), with small added errors when actual return air dry bulb and enthalpy differ from the respective setpoints. Since the

Advertisement formerly in this space.

Advertisement formerly in this space.

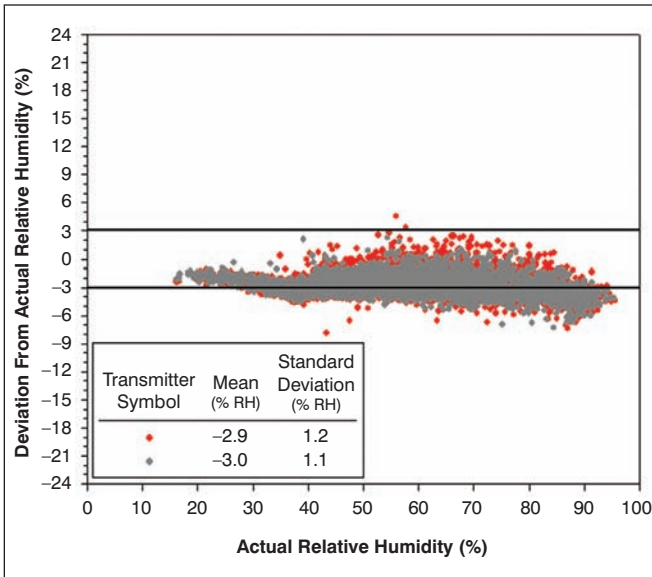

Figure 18: Iowa Energy Center NBCIP study: best humidity sensor.

Advertisement formerly in this space.

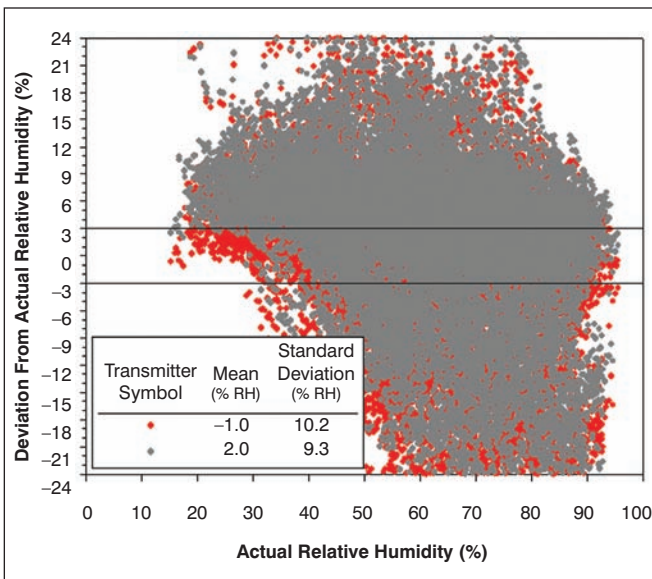

Figure 19: Iowa Energy Center NBCIP study: one of the worst humidity sensors.

fixed enthalpy logic ensures humid cool air is not selected, the dry-bulb setpoint should be set for the expected return air temperature (e.g., 75°F [24°C]) regardless of climate, not adjusted downward as in Figure 6.

A special type of combination high limit switch is what Standard 90.1 refers to as an “electronic enthalpy” high limit. This very clever electronic controller has been used for many years with packaged AC units with electric or electronic controls. It originally used hygroscopic materials such as nylon for humidity sensing. It is now entirely solid state and much more reliable. Its setpoints (“A” through “D”) form a curve on the psychrometric chart (Figure 16). When set to setpoint “A” (a requirement of Standard 90.1 regardless of climate), it mimics a combination of a fixed enthalpy control with a

	High Limit Control Option	Setpoint	Error	Remarks
1	Fixed Dry Bulb	See Remarks	±2°F	The fixed dry bulb setpoint was that which resulted in the lowest energy use for each climate zone. See Table 2.
2	Differential Dry Bulb	–	±4°F	Twice the error due to two sensors.
3	Fixed Enthalpy	28 Btu/lb _{da}	±2 Btu/lb _{da}	Cumulative error of ±2°F dry bulb and ±4% RH. Setpoint corresponds to 75°F and 50% RH, adjusted for elevation above sea level.
4	Differential Enthalpy	–	±4 Btu/lb _{da}	Twice the error due to two sensors.
5	Differential Enthalpy + Fixed Dry Bulb	– 75°F	±4 Btu/lb _{da} ±2°F	Error impact modeled cumulatively for both sensors (both low or both high). Differential dry bulb was not modeled because DOE-2.2 does not allow it to be combined with differential enthalpy.
6	Fixed Enthalpy + Fixed Dry Bulb	28 Btu/lb _{da} 75°F	±2 Btu/lb _{da} ±2°F	Error impact modeled cumulatively for both sensors (both low or both high). Setpoint corresponds to 75°F and 50% RH, adjusted for elevation above sea level.
7	Dew Point + Fixed Dry Bulb	55°F 75°F	±5°F DPT ±2°F	Error impact modeled cumulatively for both sensors (both low or both high). This option was analyzed only because it is listed as an option in Standard 90.1.

Table 1: Seven high limit controls and combinations modeled and summarized.

setpoint of 27 Btu/lb_{da} (63 kJ/kg) and a fixed dry-bulb control with a setpoint of 73°F (23°C). The theoretical controller error is relatively small, as shown in Figure 17 (see Page 6).

Sensor Error

The previous figures all assume perfect sensors with 0% error. Real sensors will have accuracy and repeatability limitations depending on sensor type and quality. In HVAC applications, temperature is most commonly measured using thermistors or resistance temperature detectors (RTDs). Thermistors are now the most common sensor and are typically ±0.35°F (±0.19°C). Extra precision thermistors are available with about half that error. Humidity is most commonly measured using capacitive or resistive relative humidity sensors offered in three accuracy ranges, ±1%, ±3%, and ±5% with ±3% being the most common for HVAC applications. Enthalpy is a thermodynamic property and cannot be directly measured. Rather, it is calculated from measurements of both temperature and humidity. The error is a combination of the individual sensor accuracy.

These are manufacturer-listed accuracies. Actual accuracy will vary depending on the quality of the sensor and how well and how frequently the sensor has been calibrated. Temperature sensors tend to be very stable and remain accurate for many years.^{4,5} Humidity sensors, on the other hand, are

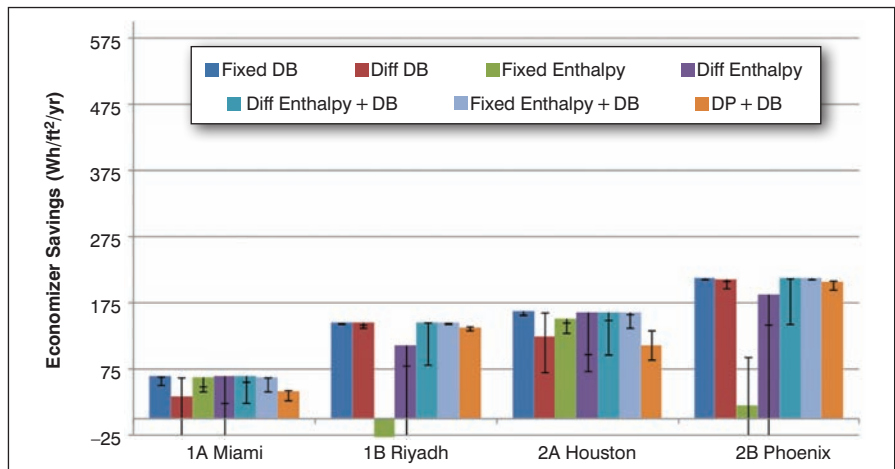

Figure 20: High limit control performance: Climate Zones 1 and 2.

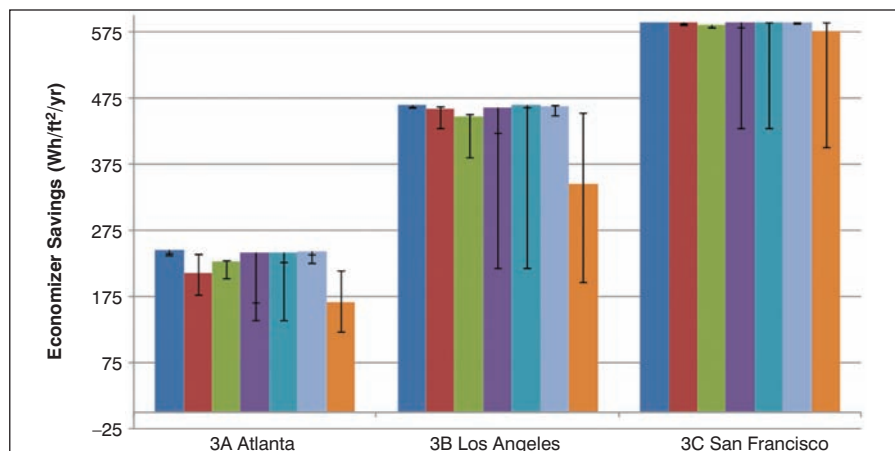

Figure 21: High limit control performance: Climate Zone 3.

notorious for being difficult to maintain in calibration. A recent test of commercial humidity sensors^{6,7} showed that few of the sensors met manufacturer's claimed accuracy levels out

of the box, and were even worse in real applications. *Figures 18 and 19* (see Page 7) show the results of the NBCIP one-year in situ tests of two brands of humidity sensors among the six brands tested. There were two sensors tested for each brand, represented by the orange and gray dots. *Figure 18* shows the best sensor in the study; both sensors were reasonably consistent and accurate, although even these top quality sensors did not meet the manufacturer's claim of $\pm 3\%$ accuracy. *Figure 19* shows the worst sensor tested; both sensors generated almost random humidity readings.

Energy Impact of High Limit Controls and Sensor Error

To test the impact on energy use of the various high limit control options including sensor error, a DOE-2.2 model was created of a typical office building. DOE-2.2 was used (as opposed to other simulation engines like EnergyPlus) because it is capable of modeling high limit sensor error. The building modeled is a one-story, 40,000 ft² (3716 m²) gross area, and served by a variable air volume system and an all-variable speed chilled water plant. The building envelope was adjusted to meet Standard 90.1 requirements in each of the climate zones tested.

Sensor error was assumed to be $\pm 2^\circ\text{F}$ ($\pm 1^\circ\text{C}$) for dry-bulb sensors and $\pm 4\%$ RH for humidity sensors. These assumptions are deliberately skewed toward penalizing the dry-bulb sensors and ignoring the significant evidence of poor performing humidity sensors (e.g., *Figure 19*) to make our conclusions below even more credible. Error was modeled as cumulative for multiple sensors (both low or both high), rather than using a statistical (e.g., root mean square⁸) approach to bound the possible error.

Seven high limit controls and combinations were modeled, summarized in *Table 1* (see Page 8). Assumed combined sensor accuracy is listed. A $\pm 2^\circ\text{F}$ ($\pm 1^\circ\text{C}$) dry-bulb error equates to about $\pm 1.2 \text{ Btu/lb}_{\text{da}}$ ($\pm 3 \text{ kJ/kg}$) enthalpy error while a $\pm 4\%$ RH error equates to a $\pm 0.8 \text{ Btu/lb}_{\text{da}}$ ($\pm 2 \text{ kJ/kg}$) enthalpy error for a total of $2 \text{ Btu/lb}_{\text{da}}$ (5 kJ/kg) enthalpy error. This same enthalpy error can result with a perfect dry-bulb

sensor and a $\pm 10\%$ RH humidity sensor error.

Results are shown in *Figure 20* through *Figure 24* for all of the climate zones defined in Standard 90.1. The y-axis

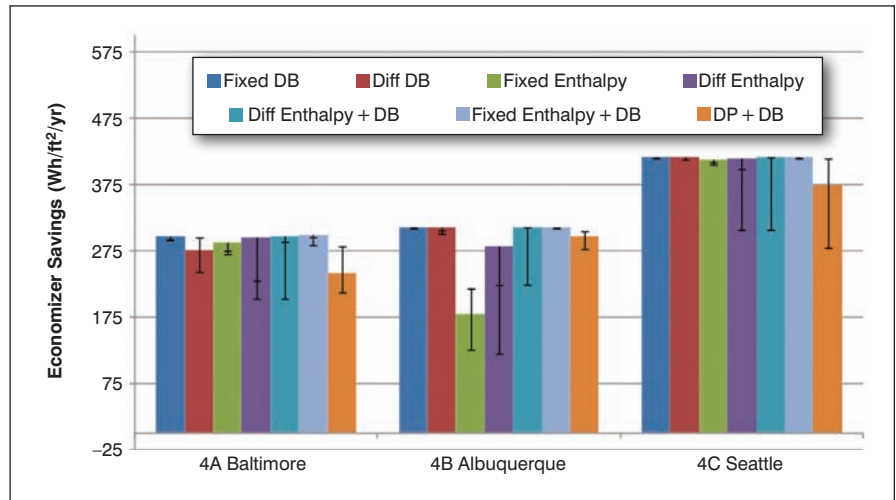

Figure 22: High limit control performance: Climate Zone 4.

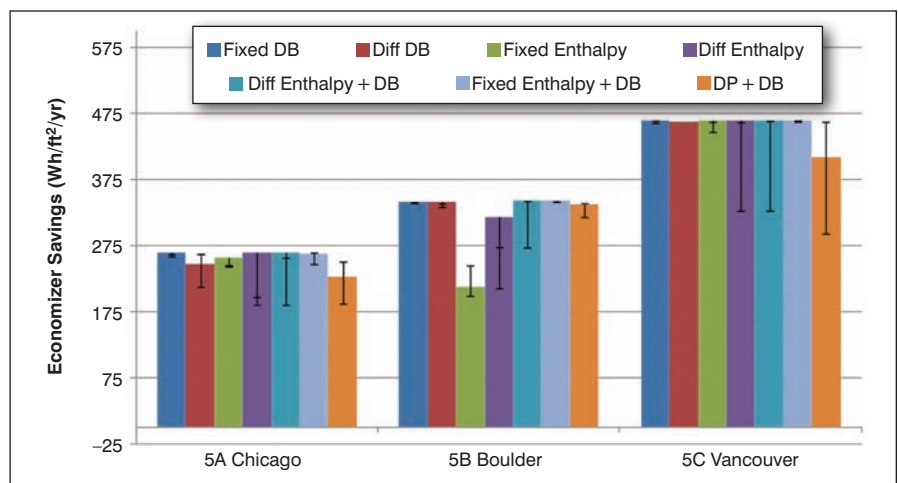

Figure 23: High limit control performance: Climate Zone 5.

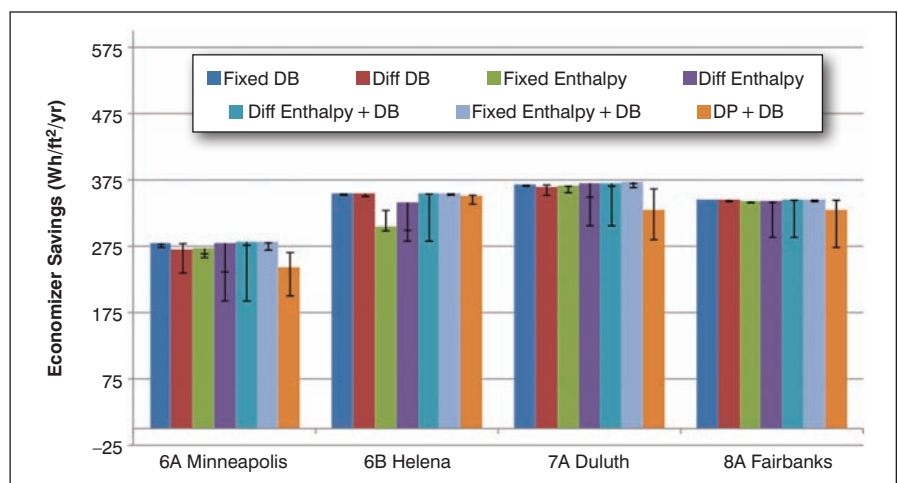

Figure 24: High limit control performance: Climate Zones 6 to 8.

Device Type	Acceptable in Climate Zone at Listed Setpoint	High Limit Logic (Economizer Off When):		Not Recommended In Climate Zone
		Equation	Description	
Fixed Dry Bulb	3C, 6B, 8	$T_{OA} > 75^{\circ}\text{F}$	Outdoor air temperature exceeds 75°F.	
	1B, 2B, 3B, 4B, 4C, 5B	$T_{OA} > 73^{\circ}\text{F}$	Outdoor air temperature exceeds 73°F.	
	5C, 6A, 7	$T_{OA} > 71^{\circ}\text{F}$	Outdoor air temperature exceeds 71°F.	
	1A, 2A, 3A, 4A, 5A	$T_{OA} > 69^{\circ}\text{F}$	Outdoor air temperature exceeds 69°F.	
Differential Dry Bulb	1B, 2B, 3B, 3C, 4B, 4C, 5B, 5C, 6B, 7, 8	$T_{OA} > T_{RA}$	Outdoor air temperature exceeds return air temperature.	1A, 2A, 3A, 4A, 5A, 6A
Fixed Enthalpy	4A, 5A, 6A, 7, 8	$h_{OA} > 28 \text{ Btu/lb}^*$	Outdoor air enthalpy exceeds 28 Btu/lb of dry air.*	All
Fixed Enthalpy + Fixed Dry Bulb	All	$h_{OA} > 28 \text{ Btu/lb}^*$ or $T_{OA} > 75^{\circ}\text{F}$	Outdoor air enthalpy exceeds 28 Btu/lb of dry air* or outdoor air dry bulb exceeds 75°F.	All
Electronic Enthalpy	All	$(T_{OA}, RH_{OA}) > A$	Outdoor air temperature/RH exceeds the "A" setpoint curve.†	All
Differential Enthalpy	None	$h_{OA} > h_{RA}$	Outdoor air enthalpy exceeds return air enthalpy.	All
Differential Enthalpy + Fixed (or Differential) Dry Bulb	None	$h_{OA} > h_{RA}$ or $T_{OA} > 75^{\circ}\text{F}$ (or T_{RA})	Outdoor air enthalpy exceeds return air enthalpy or outdoor air dry bulb exceeds 75°F (or return air temperature).	All
Dew Point + Dry-Bulb Temperatures	None	$DP_{OA} > 55^{\circ}\text{F}$ or $T_{OA} > 75^{\circ}\text{F}$	Outdoor dew point exceeds 55°F (65 gr/lb) or outside air dry bulb exceeds 75°F.	All

* At altitudes substantially different than sea level, the fixed enthalpy limit shall be set to the enthalpy value at 75°F and 50% relative humidity. As an example, at approximately 6,000 ft elevation the fixed enthalpy limit is approximately 30.7 Btu/lb.

† Setpoint "A" corresponds to a curve on the psychrometric chart that goes through a point at approximately 73°F and 50% relative humidity and is nearly parallel to dry-bulb lines at low humidity levels and nearly parallel to enthalpy lines at high humidity levels.

Table 2: High limit control recommendations for integrated economizers.

is annual savings versus no economizer in watt-hour per square foot per year. Each column in the chart shows the performance of the high limit control with no sensor error. Each column also has an error bar that shows how the control would work if sensors had the errors listed in *Table 1*. The error bar in most cases is broken into two parts: 1) if the sensor error was high and 2) if the error was low. Strategies that result in significantly increased energy use (negative savings) may extend off the charts.

Conclusions that can be drawn from these results include:

1. Dew point + fixed dry-bulb logic should not be used anywhere. As noted in *Table 1*, this control logic was analyzed only because it is listed as an option in Standard 90.1. It is not a logical control concept from an energy-efficiency perspective based on fundamentals, as indicated in *Figure*

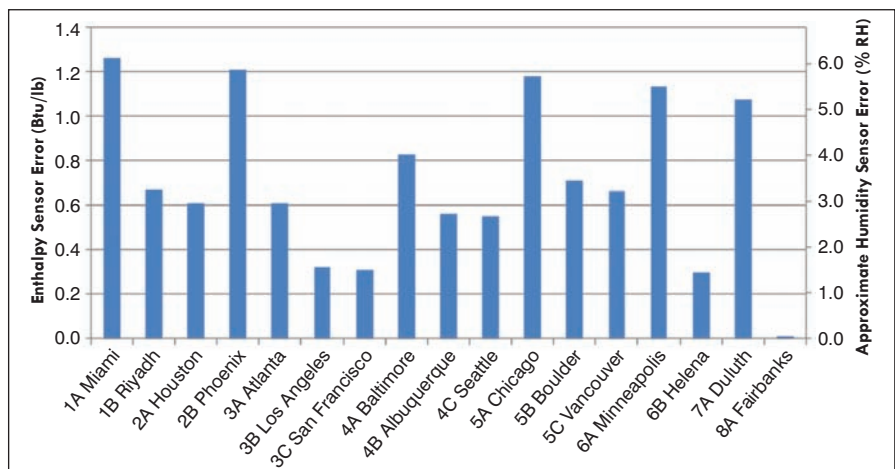

Figure 25: Required maximum differential enthalpy error to match fixed dry bulb with ±2°F (±1°C) error.

- 4, and it has the same or higher first costs as the other options.
2. Differential dry-bulb control should not be used in humid climates and fixed enthalpy control should not be used in

dry climates. In fact, Standard 90.1 already includes these limitations.

3. The best option, assuming no sensor error, is the combination of differential enthalpy and fixed dry bulb. (Actually, the best option would have been differential enthalpy/differential dry bulb, but DOE-2.2 cannot model that option.)
4. Including sensor error, the best (or very close to the best) option in all climates is simply fixed dry-bulb control, assuming the setpoint is optimized by climate (*Table 2*, see Page 10).
5. Including sensor error, the worst (or very close to the worst) option in all climates is the differential enthalpy control. This control logic is considered the “best” anecdotally among many design engineers and is required for some climate zones by Standard 189.1. Yet, in practice, with realistic (even optimistic) sensor error, it performs among the worst of all options. *Figure 25* (see Page 10) shows the maximum combined error required of a differential enthalpy control to have the same energy performance of a simple fixed dry-bulb switch with $\pm 2^\circ\text{F}$ ($\pm 1^\circ\text{C}$) error. The roughly equivalent humidity error, assuming zero dry-bulb sensor error, is shown on the right axis. In most cases, two humidity sensors with $\pm 1\%$ accuracy would not be accurate enough, again assuming no dry-bulb sensor error. This figure demonstrates that it will be almost impossible for sensors to be accurate enough for differential enthalpy control to beat a simple dry-bulb switch; and, certainly impossible for differential enthalpy control to be life-cycle cost effective versus a dry-bulb switch given the significant added first costs and maintenance costs.
6. Fixed enthalpy control when combined with fixed dry-bulb control also performs well. The error in the enthalpy sensor is buffered by the addition of the dry-bulb limit, and the dry-bulb limit resolves the inefficiency problems the fixed enthalpy sensor has in dry climates. But, it performs only slightly better than fixed dry bulb alone, even in humid climates, so it is not likely to be cost effective given the added first costs and maintenance (calibration) costs of the outdoor air humidity sensor.
7. The “electronic” enthalpy switch with an “A” setpoint imitates fixed enthalpy + fixed dry-bulb control and should perform fairly well in all climates, provided it is as accurate as is assumed in *Table 1*. Recent research⁹ has shown that older electromechanical enthalpy switches are extremely inaccurate. The most common solid-state enthalpy switches have on/off differentials on the order of the enthalpy error assumed in *Table 1* ($\pm 2 \text{ Btu/lb}_{\text{da}}$ [$\pm 5 \text{ kJ/kg}$]). Sensor error on top of that would make the performance worse. Plus, the “A” setting is not quite as efficient as fixed enthalpy + fixed dry-bulb control per *Figure 17*. Finally, “electronic” enthalpy switches are hard to calibrate or to even know that they are out of calibration. Therefore, it is hard to justify

the use of an “electronic” enthalpy switch over simple dry-bulb switch.

Conclusions and Recommendations

The results of our analysis suggest some radical changes should be made to standard engineering practice and to Standards 90.1 and 189.1 with respect to economizer high limit controls. *Table 2* summarizes our recommendations for applying high limit controls and the appropriate setpoints for integrated economizers. The climate zones that are acceptable for a given high limit control are listed in the second column. Recommended setpoints, which vary by climate zone for fixed dry-bulb controls, are shown in the third column. Note that optimum fixed dry-bulb setpoints may vary with varying “return air side” loads, such as heat gains or losses from roof conduction, recessed lights, and return fans. The right column indicates the climate zones where we do not recommend using the high limit control. Note that fixed enthalpy, fixed enthalpy + fixed dry bulb, and electronic enthalpy are acceptable in some or all climate zones, but not recommended for use in any. They have acceptable performance in the climate zones listed, but they are not recommended since they will not be cost effective compared to fixed dry-bulb controls. Fixed dry-bulb controls at the setpoint indicated are the preferred high limit device for all climate zones due to their very low first costs, inherently high energy efficiency, minimal sensor error, minimal energy impact even when there is sensor error, and low maintenance costs.

References

1. ANSI/ASHRAE/IESNA Standard 90.1-2007, *Energy Standard for Buildings Except Low-Rise Residential Buildings*.
2. Zhou, J., G. Wei, D. Turner, D. Claridge. 2008. “Airside Economizer—Comparing Differing Control Strategies and Common Misconceptions.” <http://repository.tamu.edu/handle/1969.1/90822>.
3. ANSI/ASHRAE/USGBC/IESNA Standard 189.1-2009, *Standard for the Design of High-Performance Green Buildings Except Low-Rise Residential Buildings*.
4. Edwards, T.J. 1983. “Observations on the stability of thermistors.” *Review of Scientific Instruments* 54(5): 613–617.
5. Lawton, K.M., S.R. Patterson. 2002. “Long-term relative stability of thermistors.” *Precision Engineering* 26(3):340–345.
6. National Building Controls Information Program. 2004. “Product Testing Report: Duct-Mounted Relative Humidity Transmitters.” Iowa Energy Center. www.energy.iastate.edu/Efficiency/Commercial/download_nbcip/PTR_Humidity_Rev.pdf.
7. National Building Controls Information Program. 2005. “Product Testing Report Supplement: Duct-Mounted Relative Humidity Transmitters.” Iowa Energy Center. www.energy.iastate.edu/Efficiency/Commercial/download_nbcip/NBCIP_S.pdf.
8. Feng, J., M. Lui, X. Pang. 2007. “Economizer Control Using Mixed Air Enthalpy.” <http://repository.tamu.edu/handle/1969.1/6246>.
9. Zhou, X. 2010. “Performance Evaluation: Economizer Enthalpy Sensors.” Presentation at Seminar 41, 2010 ASHRAE Winter Conference.
10. Honeywell. H705A Solid State Enthalpy Controller. <http://customer.honeywell.com/techlit/pdf/PackedLit/63-2144.pdf>, P. 8. ●